

ITEM **PB-A**  
(36")

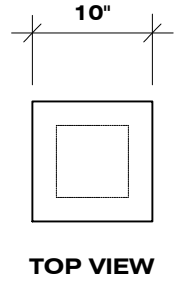
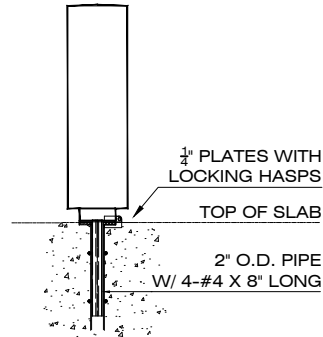
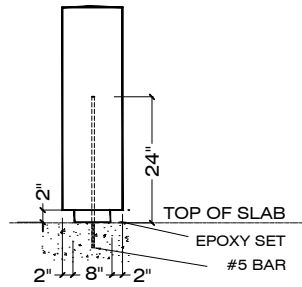
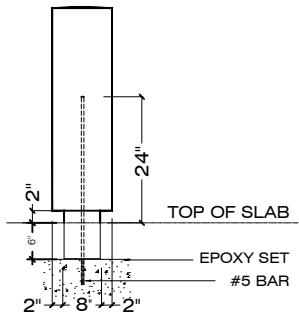

**SUBTERRANEAN MOUNT** (A)

**SURFACE MOUNT** (B)

**REMOVABLE** (C)  
IN GLASCRETE ONLY

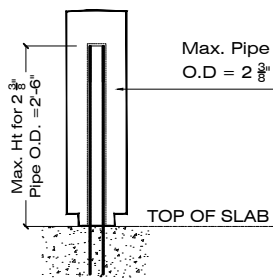

**PERIMETER SECURITY** (D)  
ANTI - RAM

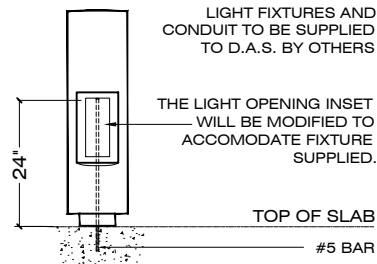

**LIGHT BOLLARD**  
MODEL NO - LB-A

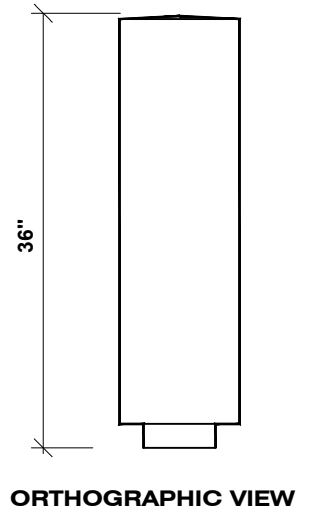

**BOLLARD TYPES AND INSTALLATION OPTIONS**

3/8" = 1' - 0

ORDER CODE: **S - PB-A - B - 36 - S-14 - LSB**

MODEL No. | HEIGHT | FINISH

PRECAST CONCRETE | MOUNTING OPTION | COLOR

**SPECIFICATIONS :**

**MATERIAL :** PRECAST CONCRETE

**COLOR :** S-1 S-2 S-3 S-4 S-5 S-6 S-7 S-8 S-9

**REBAR :** #3 BAR

S-10 S-11 S-12 S-13 S-14 S-15 S-16 S-17 S-18

**WEIGHT :** 320 LBS

**FINISH :** SK / AE / LSB / MSB

**DIMENSIONS :** 10"Ø X 36" HEIGHT

**APPROVED BY :** \_\_\_\_\_

SK: SMOOTH / AE: ACID ETCH / LSB: LIGHT SANDBLAST / MSB: MEDIUM SANDBLAST