

ITEM **PB-D**
(30")

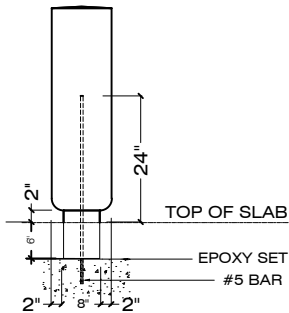

SUBTERRANEAN MOUNT (A)

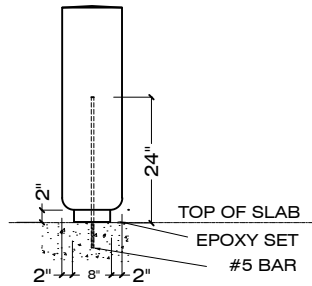

SURFACE MOUNT (B)

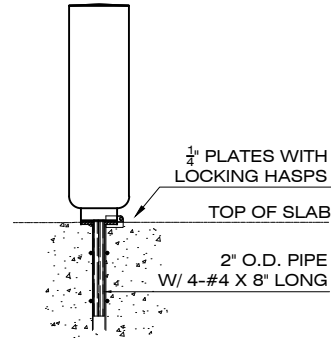

REMOVABLE (C)
IN GLASCRETE ONLY

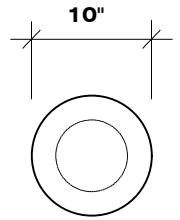

TOP VIEW

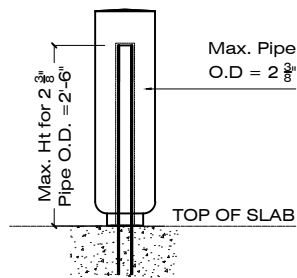

PERIMETER SECURITY (D)
ANTI - RAM

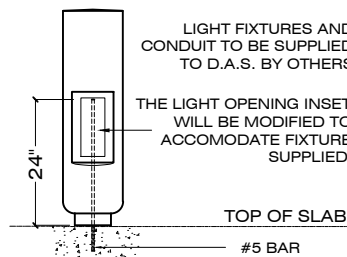

LIGHT BOLLARD
MODEL NO - LB-D

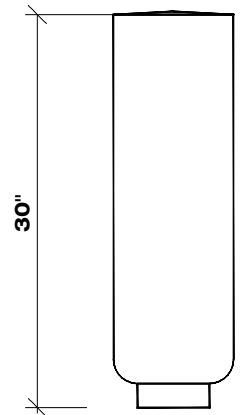

ORTHOGRAPHIC VIEW

BOLLARD TYPES AND INSTALLATION OPTIONS

3/8" = 1' - 0

ORDER CODE: **S - PB-D - A - 30 - S-14 - LSB**

MODEL No. | HEIGHT | FINISH
 PRECAST CONCRETE | MOUNTING OPTION | COLOR

SPECIFICATIONS :

MATERIAL : PRECAST CONCRETE

COLOR : S-1 S-2 S-3 S-4 S-5 S-6 S-7 S-8 S-9

REBAR : #3 BAR

S-10 S-11 S-12 S-13 S-14 S-15 S-16 S-17 S-18

WEIGHT : 260 LBS

FINISH : SK / AE / LSB / MSB

DIMENSIONS : 10"Ø X 30" HEIGHT

APPROVED BY : _____

SK: SMOOTH / AE: ACID ETCH / LSB: LIGHT SANDBLAST / MSB: MEDIUM SANDBLAST

CONTACT: CORPORATE / ADMINISTRATIVE: 650 965 7100