

SUBTERRANEAN MOUNT (A)

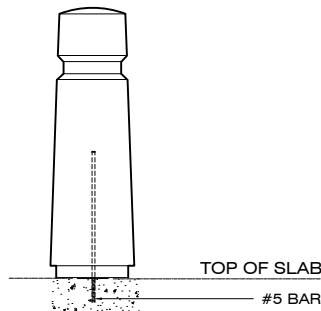

SURFACE MOUNT (B)

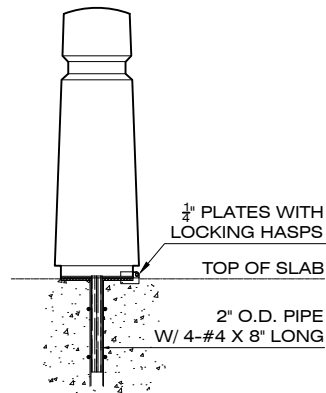

**REMOVABLE (C)
IN GLASCRETE ONLY**

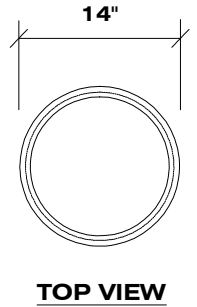

TOP VIEW

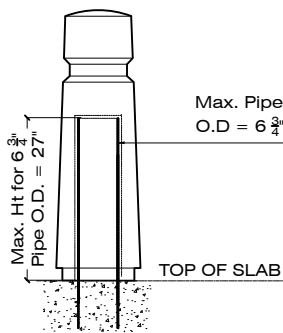

**PERIMETER SECURITY (D)
ANTI - RAM**

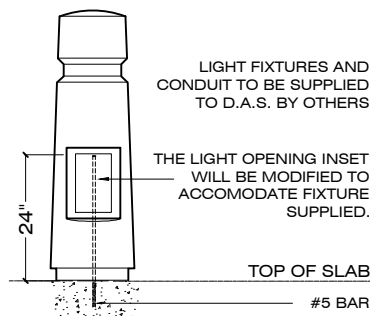

**LIGHT BOLLARD
MODEL NO - LB-H2**

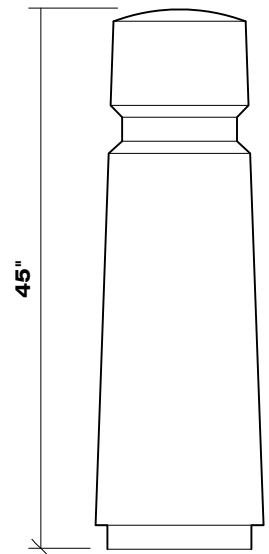

ORTHOGRAPHIC VIEW

BOLLARD TYPES AND INSTALLATION OPTIONS

3/8" = 1' - 0

ORDER CODE: **S - PB-H2 - A - 45 - S-14 - LSB**

MODEL No. | HEIGHT | FINISH
 PRECAST CONCRETE | MOUNTING OPTION | COLOR

SPECIFICATIONS :

MATERIAL : PRECAST CONCRETE

COLOR : S-1 S-2 S-3 S-4 S-5 S-6 S-7 S-8 S-9

REBAR : #3 BAR

S-10 S-11 S-12 S-13 S-14 S-15 S-16 S-17 S-18

WEIGHT : 720 LBS

FINISH : SK / AE / LSB / MSB

DIMENSIONS : 14"Ø X 45" HEIGHT

APPROVED BY : _____

SK: SMOOTH / AE: ACID ETCH / LSB: LIGHT SANDBLAST / MSB: MEDIUM SANDBLAST

CONTACT: CORPORATE / ADMINISTRATIVE: 650 965 7100